



User manual

Before you start please read the manual carefully before you use the steering wheel.

Any modifications, tampering, changes or unauthorized uses of the product will void the warranty.

The steering wheel has no waterproof feature, please keep it away from water, rain, moisture and other items containing liquid such as vape, cups etc.

This wheel is designed for simulation purposes only.

Disconnect the USB cable from both sides if you will not use the product for a long time.

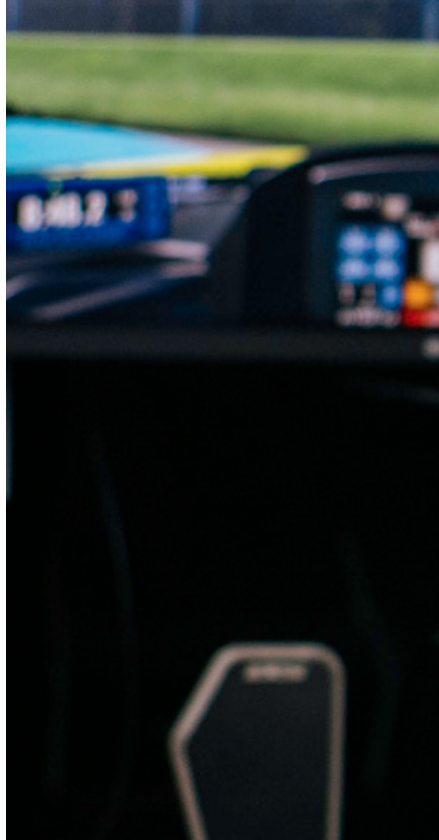



BIAS 59

POS 1/1

LAP 8/10

GAP 0

FL 70

FR 70

FL 70

FR 73

TCS 5

1

GEAR

FUEL 10

SPEED 0

ABS 5

SCROLL

LAST 01:50.240

BEST 01:47.320

OPTIMAL 01:50.240

DELTA +510.5

MAP 1

TCT



800x480 LCD with touch screen

Native Simhub support

21 RGB LEDs

All buttons, dials and LED bars compatible
with Simhub via a dedicated plugin



Contents

1. INTRODUCING THE HARDWARE

- 1.1 Interface
- 1.2 Steering Wheel Installation
- 1.3 Shifter Paddles Adjustment
- 1.4 Clutch Paddles Adjustment
- 1.5 Connecting the GTX-2

2. NAVIGATING THE SOFTWARE

- 2.1 Introduction
- 2.2 Inputs
- 2.3 RGB
- 2.4 Paddles
- 2.5 Device
- 2.6 About

3. CONNECTING SIMHUB

4. USEFUL TIPS

What you will find in the box

- ❏ GTX-2 Steering Wheel
- ❏ Q-CONN USB Cable
- ❏ 1x Stickers 3.0 Sheet
- ❏ Tool Bag containing:
 - ❏ Torx Screwdriver (red)
 - ❏ Philips Screwdriver (black)
 - ❏ TX10 Allen key
 - ❏ TX20 Allen key
 - ❏ TX25 Allen key
 - ❏ Nylon Tweezers
 - ❏ 3x M5x10 hex bolts
 - ❏ 3x M5x16 hex bolts
 - ❏ 3x M5x10 button TORX
 - ❏ 3x M5 nut

1. INTRODUCING THE HARDWARE

1.1 Interface

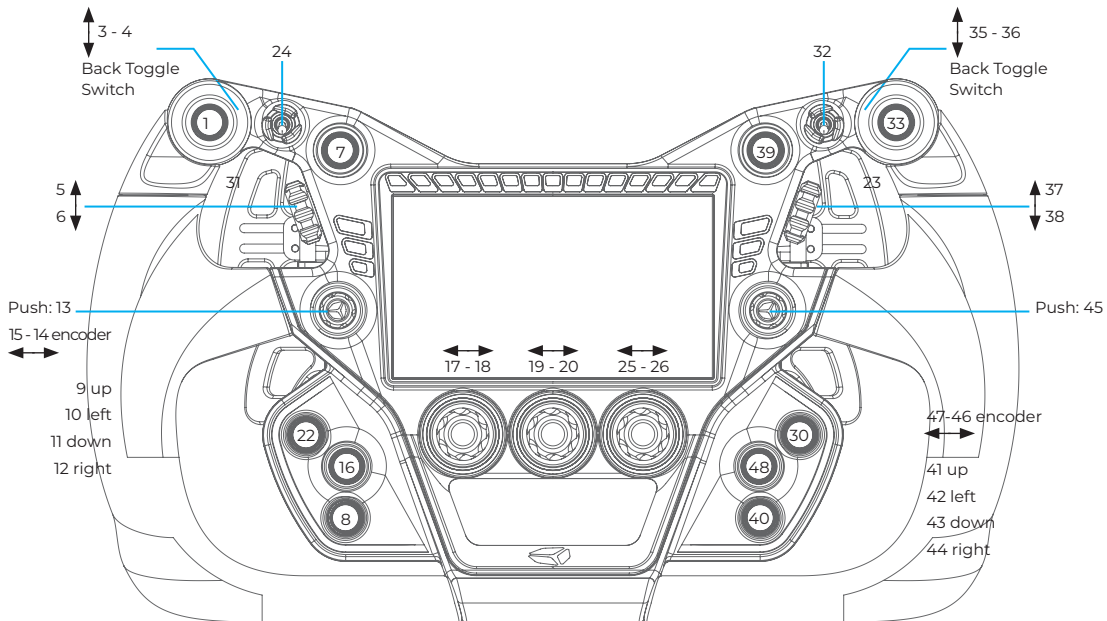

The **POV switches**/funky switches/joysticks directions (up, down, left, right) are meant to work only if a “clicky” sound feedback occurs. Therefore there’s no risk to press the direction and accidentally enable the centre click button.

Toggles **24** and **32** work this way: once the toggle has been activated the respective led will turn on, when the toggle has been flipped off it turns the led off. In the ON status the respective button is not seen as always pressed, it only activates the button for a few ms when flipped on or off. Toggles are useful for on/off features like headlights, wipers, ABS/TC etc. Make sure the toggle LEDs are synced correctly: e.g. if you activate one option without being in the sim, it will work in reverse once you are into the simulator.

IMPORTANT: Remember that on the Windows USB Game Device page, half the buttons will not engage. This is caused by the Windows’ Graphic Interface inability to see more than 32 Buttons and not a problem with the Steering Wheel itself!

1.2 Steering wheel installation

Our universal hub on the back of the wheel body allows the user to install various adapter, or even connect it directly to your FFB base.

Highlighted in blue are the M5x0.8 metric holes. In grey, 5,5mm through holes. Both of them are available in 70mm or 50.8mm bolt patterns.

Through holes are rotated by 180°, so flipping your adapter to match the wheel hub may be needed. Please refer to your adapter or motor manufacturer to ensure compatibility.

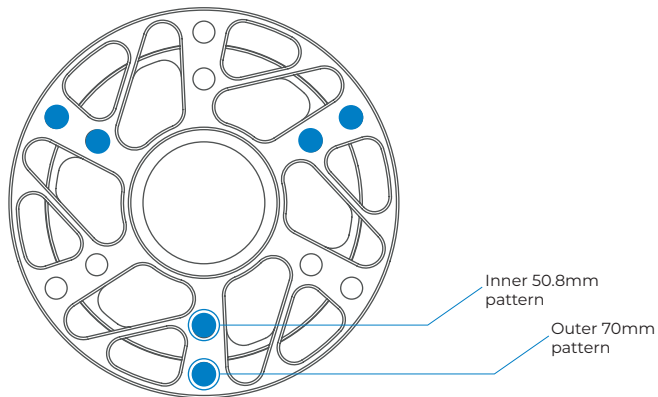

❖ 1.3 Shifter Paddles Adjustment

Shifter paddles can be easily adjusted to better suit your hand size and driving preferences.

NOTE: TX10 drive needed.

All steering wheel screws are tightened with a tightening torque of **3.5 Nm**, except for the two screws indicated in red, tightened with a tightening torque of **4 Nm**. Length can be adjusted by slightly loosening the two screws highlighted in the right picture, and sliding forward/backwards the carbon paddle.

Reach can be adjusted by slightly loosening the two screws highlighted in the right picture and the two on the opposite side of the shifter as pointed by the small arrows, then rotating the lever body upwards/downwards. You may need to apply a bit of force.

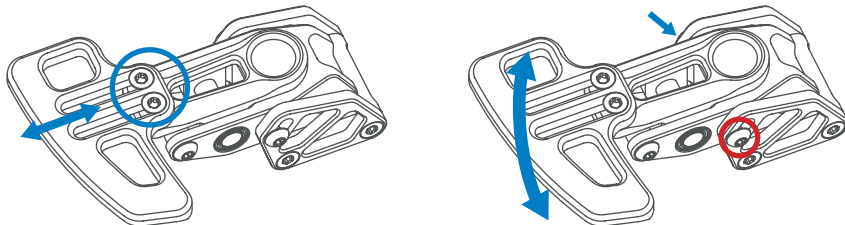

Caution: do not use a tightening torque higher than **4 Nm** to avoid any damage to the screws or the paddles' carbon body.

1.4 Clutch Paddles Adjustment

The travel of the clutch paddles can be adjusted in the same way as the shifters. Spring resistance can be adjusted by turning the screw by using the provided **TX10 Allen Key** (smallest L-shaped silver key) as indicated in the picture below:

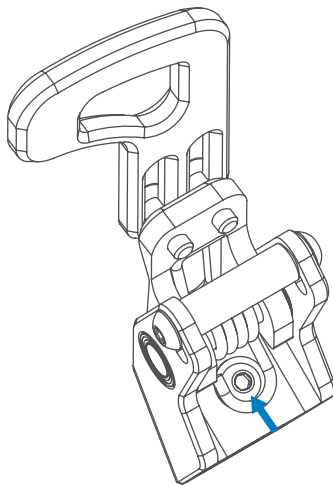

1.6 Connecting the GTX-2

Our GTX-2 has the most reliable connection we designed yet!

Thanks to the Q-CONN, connecting your steering wheel have never been this easy:

Just plug the Q-CONN connector on the back of the device.

Having done that, remember to press the On/Off button on the back of the wheel and the operative system should immediately recognize the device. You will hear the common USB connection sound.

It's time to download and start your CubeSet App!



QRX MODE OR NORMAL MODE?

On the back of the GTX-2, inside the main hub, you will find a micro switch (just under the white connector for the QRX).

That switch decides whether the GTX-2 is in Normal Connection Mode (through the Q-CONN) or in QRX Mode (through the QRX)

If you intend to use the GTX-2 in conjunction with one of ours QRXs, you will first need to put the steering wheel in QRX mode! If instead you need to connect the steering wheel using the Q-CONN, make sure the micro switch is on Normal.

2. NAVIGATING THE SOFTWARE

❖ 2.1 Introduction

The CubeSet app is here and you can download it from our website.

Now, thanks to our proprietary software you can configure your Steering Wheel in every little detail and most of all you can update your wheel firmware with new content that we release continuously.

The CubeSet App is compatible with the new line only: the older Formula and GT models are not compatible with the new software.

We have many plans for the future so do not worry: many features will be added to your CubeSet App!

IMPORTANT: With every major change in the Software we also release a new updated version of this manual. Please make sure you're consulting the correct version for your Software/Firmware.

STARTING THE CUBESET APP

Once the steering wheel is connected and recognized by the PC (see the **Connecting the GTX-2** section of this guide), you can then start the CUBESET APP.

If the wheel is successfully recognized by the CUBESET APP, this is what you will see at the top of the window:

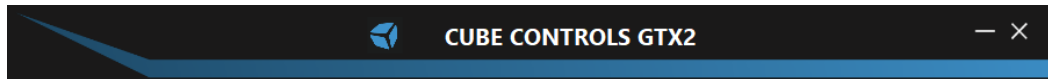

If the wheel is not connected to the PC or not successfully recognized, this is what you will see at the top of the window:

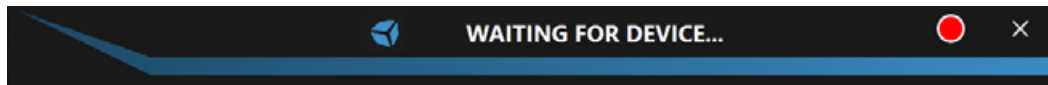

If the wheel is connected to the PC, you can finally start configuring your steering wheel!

2.2 Inputs

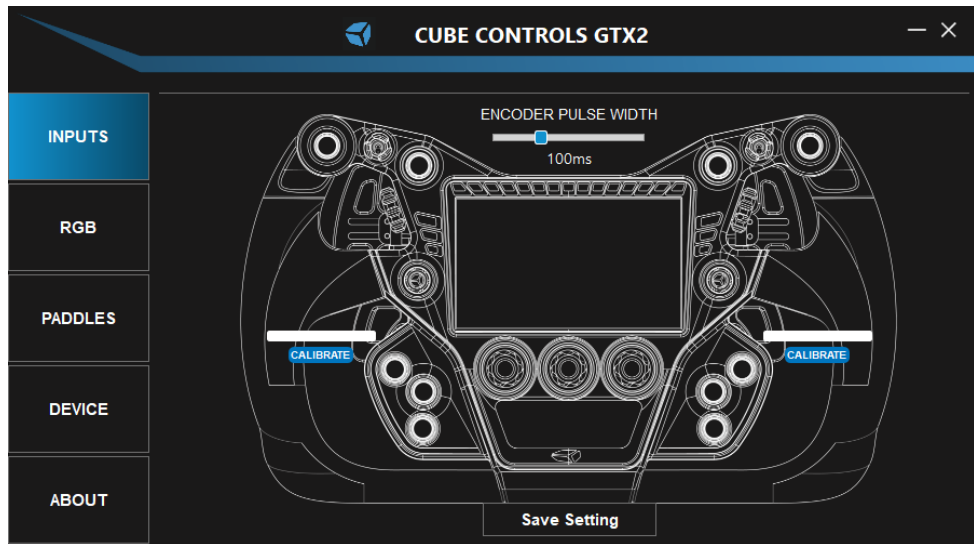

On the INPUTS page, you can check the correct functionality of every button and encoder present in your wheel, modify the Encoder Pulse Width and calibrate the Clutches.

CHECKING THE BUTTONS

Nothing is easier than that: every button press or encoder rotation on the Steering Wheel will consequently light up the corresponding button/encoder showing their correct input number.

ENCODER PULSE WIDTH

With this slider, you will be able to set a value between 40ms and 240ms for your Encoder Pulse Width! The higher the value, the longer the pulse, ensuring the inputs are recognized by every system/simulator. The lower the value, the shorter the pulse, ensuring the quickest reaction for high-end systems/simulators.

CLUTCHES CALIBRATION

Before using the analogue clutch paddles it is necessary to calibrate them, or else they might not be recognized correctly by the system/simulator.

IMPORTANT: Before calibration make sure the Clutches are set as **Enabled** and the Bite Point is **Disabled** on the Paddles page.

The process is simple: when connecting the CSX-3 for the first time the clutches could be not correctly recognized in their full course when pressed.

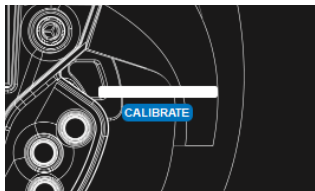

In this case, clicking on “CALIBRATE” will make the RAW values of the clutch appear. Pressing now the clutch full-course will make the system set the correct minimum and maximum values.

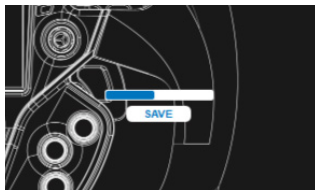

After that, simply click “SAVE”. Now the Clutch is correctly calibrated!

IMPORTANT: Remember to click **SAVE SETTINGS** after the calibration.

2.3 RGB

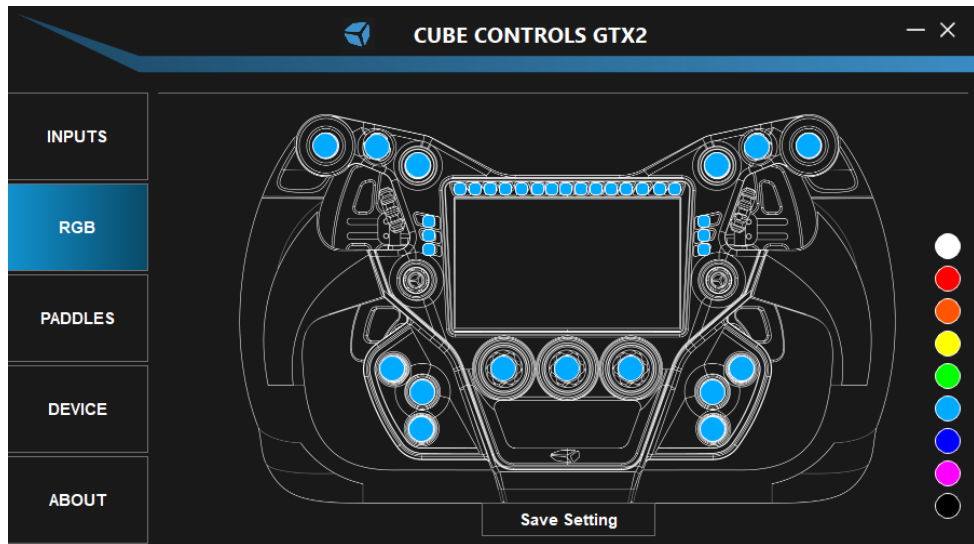

On the RGB page, you can customize every RGB LED present on the wheel in colour and brightness.

RGB CUSTOMIZATION

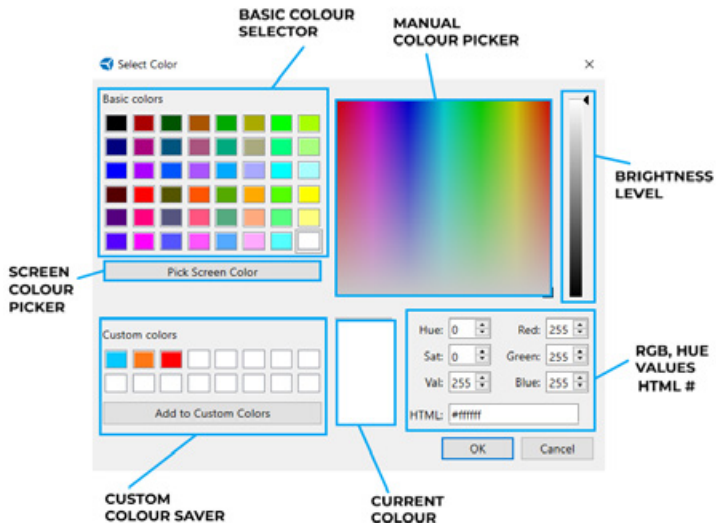

The system here is quite straightforward: you can select your colour from the classic ones, or pick your favourite, and then add it to Custom Colours. Oh, and remember to select the Brightness level!

For those of you who have their image reference on the PC, you can also use the screen colour picker to reproduce whatever colour you see on your screen. Instead, if you want your colours to be totally precise you can always modify the RGB, Hue, Saturation and Value for the colour (we also have the alphanumeric HTML!)

To make any changes quicker we have also added some basic colours profiles on the right side of the screen. Simply select one of those colours and all LEDs on the steering wheel will change accordingly!

After that, simply click OK to save the results and Cancel to abort all modifications.

IMPORTANT: Remember to click **SAVE SETTINGS** when you finish.

Also note that further LEDs customization is possible through the Simhub software, as the steering wheel is natively compatible! Keep also in mind that every LED configuration made on Simhub will supersede the ones on the Cubeset App!

2.4 Paddles

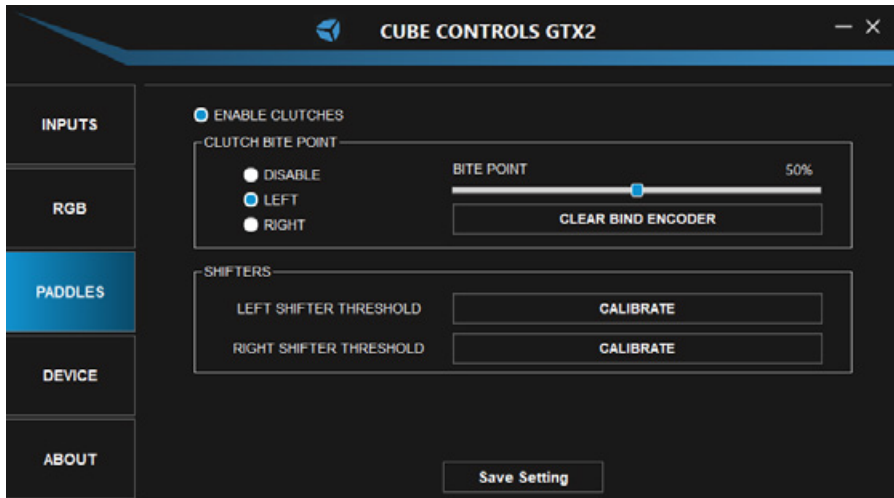

On the PADDLES page, you have the CLUTCHES section and the SHIFTERS section. In the CLUTCHES section, you can enable/disable the clutches and the Bite Point. For the Bite Point, you will also be able to select the Slave Clutch to be the Left or the Right one and then limit the percentage for it. In the SHIFTERS section, you will be able to Calibrate automatically the shifters to ensure full compatibility!

CLUTCHES SECTION

Once you calibrate the Clutches on the Inputs page, it is time to set the Bite Point! By default, the maximum value of the Slave Clutch can be adjusted with the respective slider. Therefore, if the clutch slider is set in the middle of its travel when fully depressing the left clutch paddle, its value will go from the minimum to half of the maximum value. On the other side, the Master Clutch will instead always work in a range from min to max travel, no matter how the clutch slider is set. This system allows the user to mimic the launch control system used in F1 cars until 2015 when it was possible to set the Clutch Bite Point.

Finding the correct Clutch Bite Point setting

In a practice session, set the clutch slider at around 50% of its travel, fully depress both clutch paddles, engage first gear, reach the optimal engine RPM, and release the right clutch paddle. As the car starts gaining speed, release the left clutch paddle and shift gears as normal. If you notice that the clutch starts slipping too much, you will need to decrease the left clutch paddle max value. If you notice that the engine drops quickly in RPM, then you will need to increase the clutch slippage by increasing the slider value.

This value is typically different for each car and different track conditions.

By default, the Master Clutch is the right one and as such will always operate from min to max value. It is possible to swap the Master Clutch and select the left one, and it is also possible to set the analogue paddles to be separate instead of combined.

This way the Launch Control will be no longer available and this is a valuable feature, especially for users with leg impairments since it allows them to be set as Throttle and Brake directly on the Steering Wheel.

IMPORTANT: After each value modification, remember to press the **SAVE SETTINGS** button.

Setting the Bite Point on the fly

It is also possible to modify the Bite Point on the fly, without going back to the CubeSet app in the middle of your driving session!

To do so, you will need to set an encoder of your steering wheel for this function. Nothing easier! First of all click the button under the Bite Point slider, to start the process. Then you will be prompted to **rotate an encoder to bind the bitepoint.**

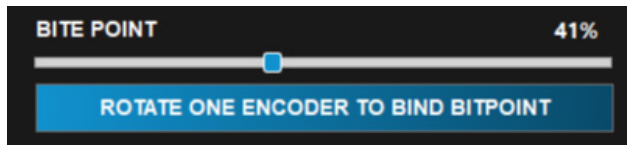

IMPORTANT: Every change is sent from wheel to software in real time, so you will need to keep the app open at all times when using the wheel to make sure the data flow is not interrupted.

SHIFTERS SECTION

After the first use, you may notice some missing or double shifts. This is caused by different systems incompatibilities that may diminish or increase the input duration, making the shifting incorrectly recognized. Because of this, you will need to directly intervene and calibrate the value for the two shifters separately to reach the perfect shifting. Do not worry, as this process is really easy!

First of all, you will need to click the **CALIBRATE** button as shown in the image below.

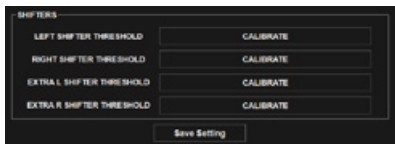

The CALIBRATE button will be replaced by the message "press and hold the left shifter then click me".

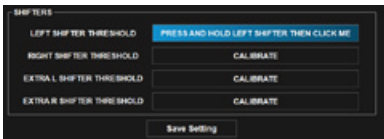

Following the instructions press and hold the corresponding shifter and then click the button. The shifter paddle is now perfectly functional! Repeat on the other one and you will be good to go.

IMPORTANT: Remember to click **SAVE SETTINGS** after the calibration.

Please also note that if you have purchased and correctly mounted the two additional paddles, you will be able to also calibrate them here! Remember to Enable them at the top of the page and follow the same exact procedure.

2.5 Device

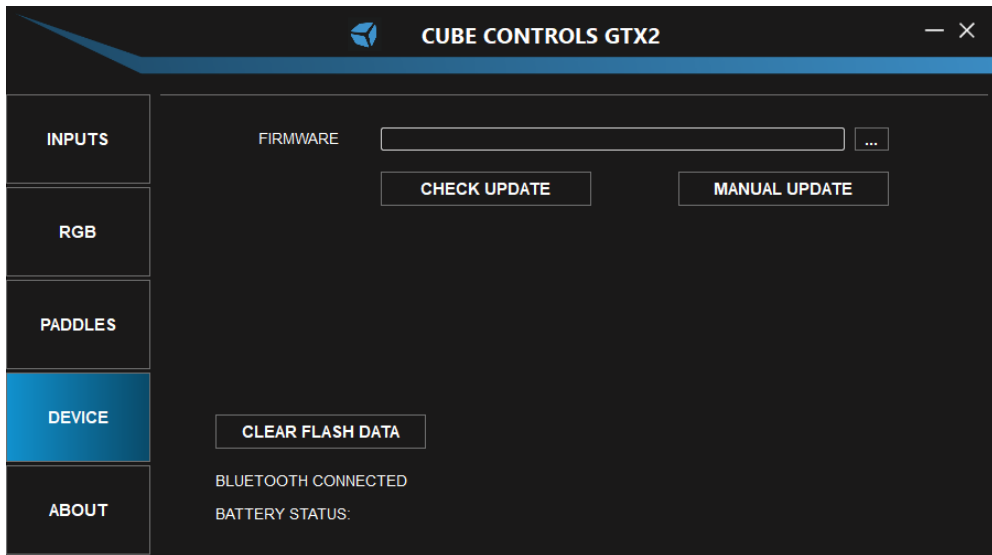

On the DEVICE page, you can update your steering wheel's Firmware and Factory Reset your wheel.

UPDATING THE FIRMWARE

When updating the firmware you have two choices: you can check online for updates (CHECK UPDATE) or, if you already have downloaded the new firmware update on your PC, you can select it and upload it manually (MANUAL UPDATE).

CLEAR FLASH DATA

If you need for whatever reason to do a Factory Reset of your steering wheel, you can now use this button and clear everything in its memory with just a click!

2.6 About

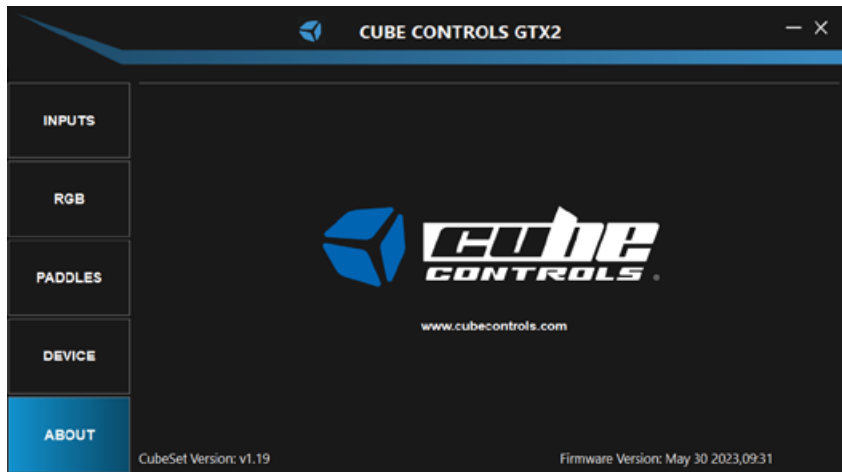

On the ABOUT page, you can find additional information like the Firmware version your steering wheel is on or the CubeSet App version.

3. CONNECTING TO SIMHUB

3. Connecting to SIMHUB

Simhub compatibility is natively guaranteed on the GTX-2!

Thanks to Simhub the RGB LEDs can be now customized to blink/change colour/switch on and off according to your SimHub configuration, making your experience with Cube Controls even deeper.

NOTE: The latest compatible version of Simhub is the **8.1.2**.

You can download the latest version on the official Simhub website!

SETTING SIMHUB

Starting Simhub, on the left you will find the Devices tab. There, you will be able to simply add the selected compatible device. Just press on **ADD DEVICE**.

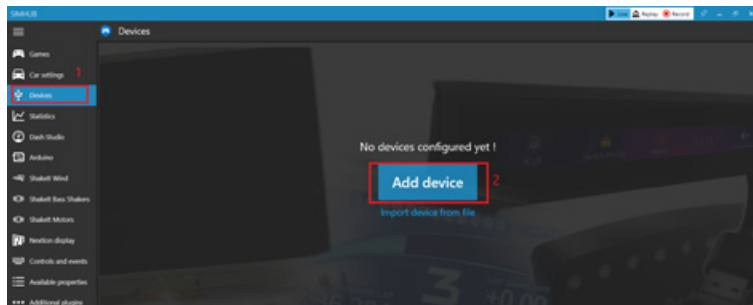



Select your steering wheel from the list:

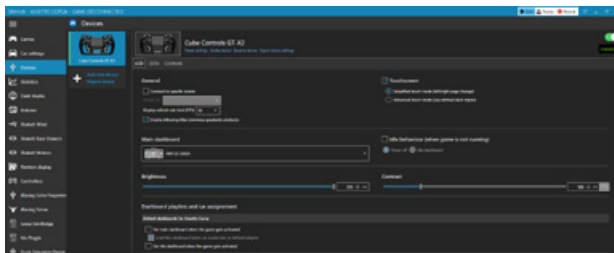

You can now create multiple profiles and edit them with various effects and functions: thanks to the Simhub versatility, the only limit is your own imagination!

IMPORTANT:

The GTX-2 uses a Vocore screen, so make sure you download the correct drivers from the Simhub website to make it work properly!

4. USEFUL TIPS

Each wheel comes with a full sheet of stickers and a set of plastic tweezers useful to install them to your liking. Before applying the sticker make sure the surface it's clean.

Try to install the USB coiled cable by wrapping it loosely on your FFB motor shaft/adaptor in such a way that it will not suffer any strain even when doing full opposite steering rotations.

Make sure your rig is grounded correctly.

Each wheel comes with an auxiliary USB connector that comes out from the main hub.

This will be used with our Cube Controls QRX quick-release kit.



www.cubecontrols.com